

# K9-F28-1 & K9-F28-1-SDS-2 INSTALLATION INSTRUCTIONS

## K9 Kit for 2020-2026 FORD INTERCEPTOR UTILITY

**TOOLS Needed:**

Phillips Screw Driver	Trim panel removal tool	Caulk Gun	Drill & drill bits
Standard Socket set	Wire Cutters /Crimpers	Metric Socket set	

**PARTS & HARDWARE:**

<u>QTY</u>	<u>DESCRIPTION</u>	<u>PART # White</u>	<u>PART # Black</u>
1	Front bulkhead with sliding door	18879	18880
2	Lower "B" pillar bracket		18848
2	Upper "B" pillar bracket		18849
1	Rear bulkhead	24586	24587
1	Rear bulkhead cross support bracket	18846	18847
1	Driver side floor section		23181
1	Passenger side floor section		23182
1	Driver side floor step	18803	18804
1	Passenger side floor step	18805	18806
2	Hot-N-Pop gas spring hole cover	18858	18859
1	Front floor bracket		22980
1	Rear floor bracket		22981
1	Ceiling	18960	18962
1	Passenger side upper rear side filler panel	18958	18959
1	Passenger side upper trim panel	18835	18836
1	Passenger side lower trim panel	18819	18820
1	Passenger side / side ceiling trim panel	18843	18844
1	Driver side upper rear side filler panel	18956	18957
1	Driver side upper trim panel	18831	18832
1	Driver side lower trim panel	18815	18816
1	Driver side / side ceiling trim panel	18839	18840
1	Driver side door panel (DP-F28-1A)	14607	14608
1	Passenger side door panel (DP-F28-6A)	14621	14622
2	Speaker cover		14628
1	Driver side hinged window guard (WGI-F28-1-K9)		21249
1	Passenger side hinged window guard (WGI-F28-6-K9)		21250
1	Rubber Mat		18972
1	Silicone caulk (sealant)	20011	20012
1	Dome Light Kit	K9-A-106	
1	SDS divider	55286	55285
1	SDS top shelf	55288	55287
1	SDS bottom shelf	55292	55291

**C-HK-350**

44	1/4" serrated flange nut	16086	
49	1/4" Flat washer - SS	16154	
26	1/4" x 1/2" Carriage bolt	16233	(for "B" pillar brackets & speaker covers)
18	1/4" x 3/4" Carriage bolt – SS	16235	
49	1/4" x 3/4" Phillips pan head screw - SS	16618	
10	#10 x 1/2" Phillips flat head sheet metal screws - SS	16641	
32	#10 x 1/2" Phillips pan head sheet metal screws - SS	16655	
4	1/4-20" x 3/4" Self-threading screw	16359	

**Always!**

- Read all instructions before installing any Havis, Inc. products.
- Use hardware provided with install kit

# K9-F28-1 Assembly

Part numbers for white sheet metal parts shown

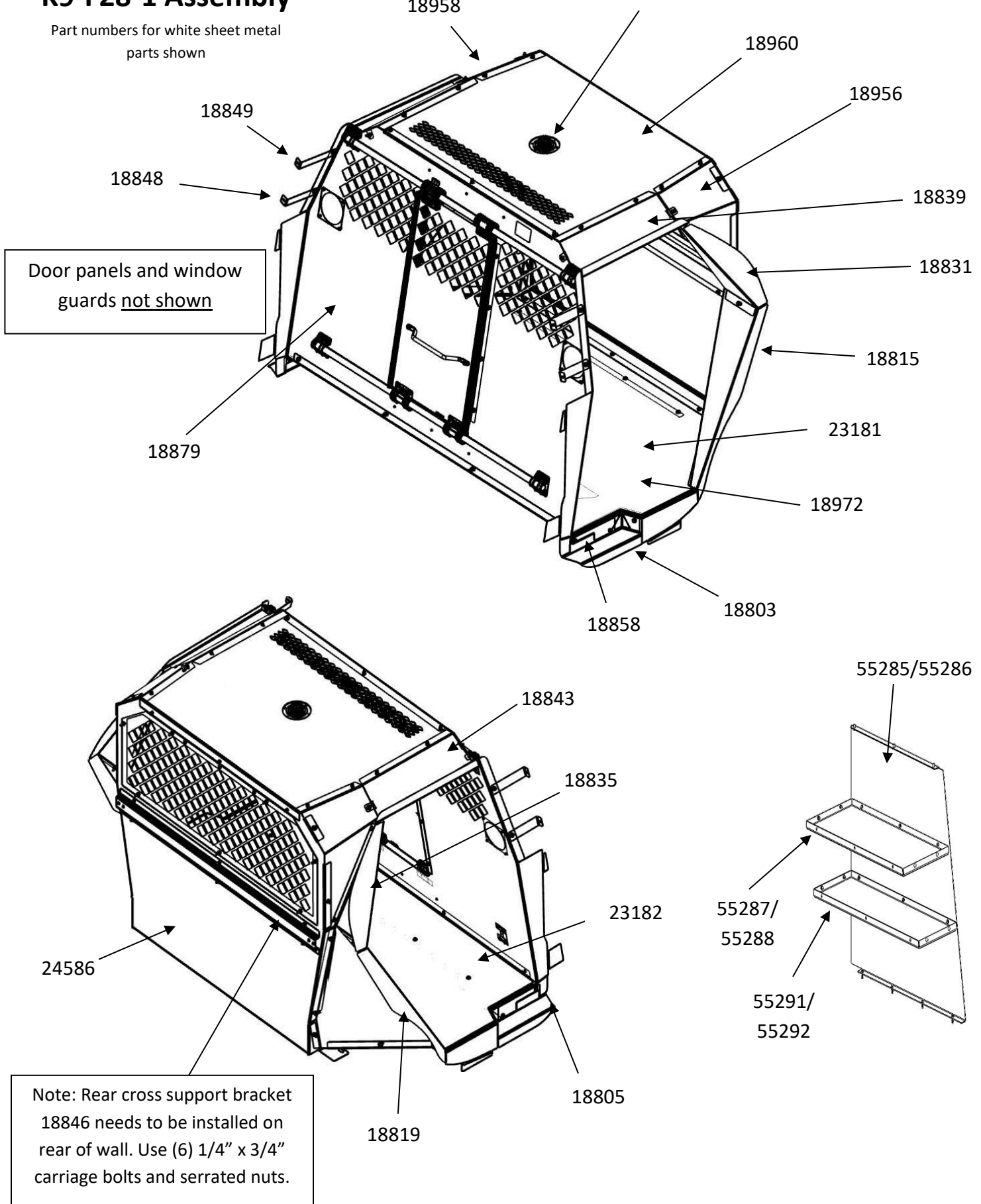



Remove rear passenger door panels first. Behind the door open paddle handle and grab handle, remove plastic cover and 10mm head bolts. Remove two 7mm head fasteners from bottom of door.

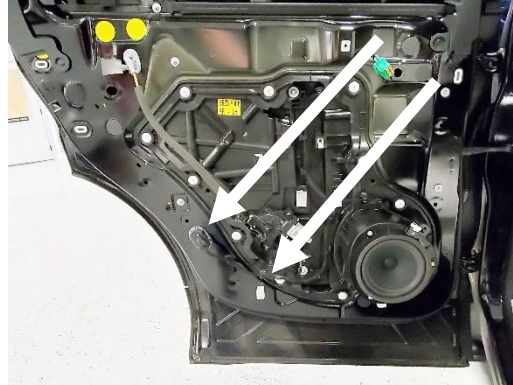

Remove plastic screw retainers from bottom of door. *These will not be reused.* Carefully push grommet with harness inside door. This will allow new door panel to fit closer to mounting surface.



Remove door speaker. (7mm socket). Prior to next step, attach Speaker cover to door panel with 1/4"x1/2" carriage bolts and serrated nuts.

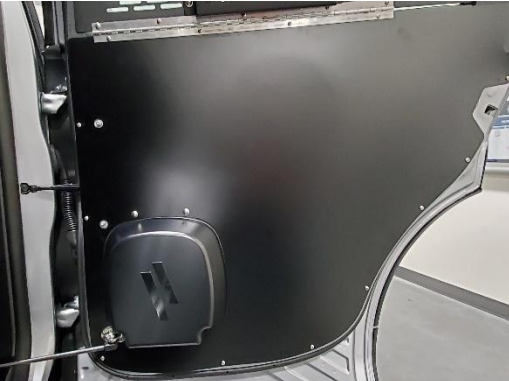

Place K9 kit door panel onto door. The top will hook onto rubber molding. Position so it lines up with the two existing (protruding) bolts.

Drill mounting holes in door with 1/8" drill bit. Attach door panels with supplied #10 x 1/2" Phillips pan head sheet metal screws.

**Note:**

**It is always highly recommended to use a drill stop to eliminate the possibility of drilling too deep.**

Check remote door unlock feature before closing door.

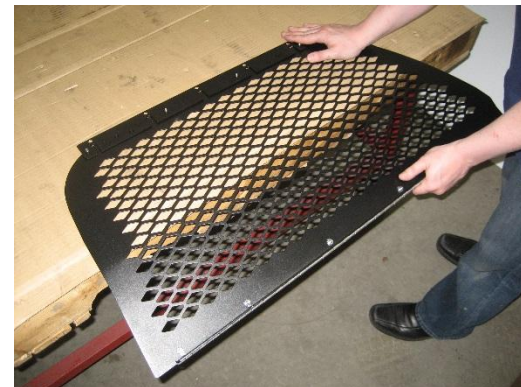

**NOTE: Window guards are shipped flat. On the edge of a work bench, bend a contour in the middle of the guard so it will fit tight against the window frame.**

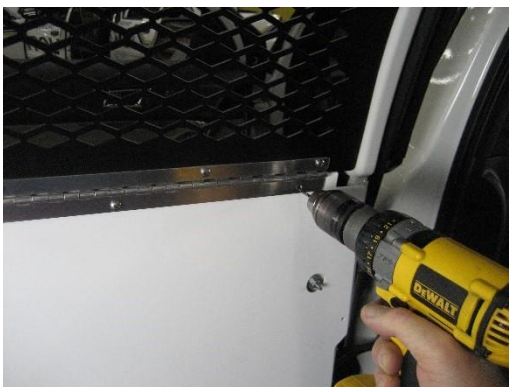

Position window guard with hinge assembly inside window frame and attach hinge to door panel pre-punched holes with supplied # 10 x 1/2 Phillips pan head sheet metal screws.



With upper mount bracket attached to window guard, mark mounting hole locations in upper door / window frame. Drill 5/32 holes.



Attach upper mount bracket to door frame with supplied #10 x 1/2 Phillips flat head sheet metal screws.

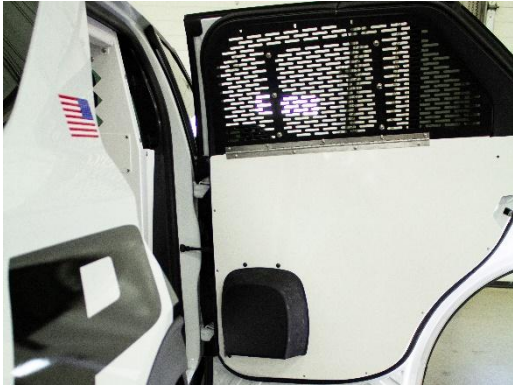

Door Panel and Window Guard complete. See last page of instruction if mounting fan to window guard.



Remove back seats and set aside. Hardware will be reused.



Remove rear floor sections. T-55 Torx socket will be needed for the forward floor section bolts.



The (3) seat belts on the back seats have built in sensors that will turn on an indicator on the dash. They must be removed from the OEM seats.  
(T-50 Torx)

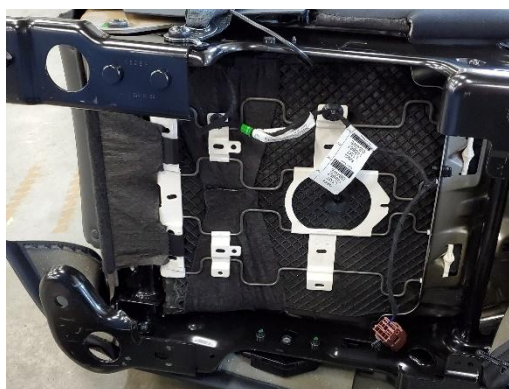

Remove the seat belt harness from the bottom of the seat.



Reconnect harness and wire tie seat belts to the OEM cross brace and plug back in.

**Note: Make sure to connect back into the original plug. Double check that the pins in plugs did not come loose.**



Use OEM bolts to attach K9 kit front floor bracket to OEM seat mount locations.

**Note: OEM lower door sill trim must be removed and not reused.**



Use OEM bolts to attach K9 kit rear floor bracket to OEM cross brace.

**Note: Route wire harnesses as needed prior to mounting K9 floor.**



Place floor into vehicle on floor brackets.



Side floor steps must be attached with 1/4" x 3/4" Phillips head screws and 1/4" washers prior to installing floor. If Hot-N-Pop system is not used, attach side cover plate over floor access hole with existing 1/4" floor hardware.



Attach floor to brackets using (8) 1/4" x 3/4" Phillips head screws and 1/4" washers.

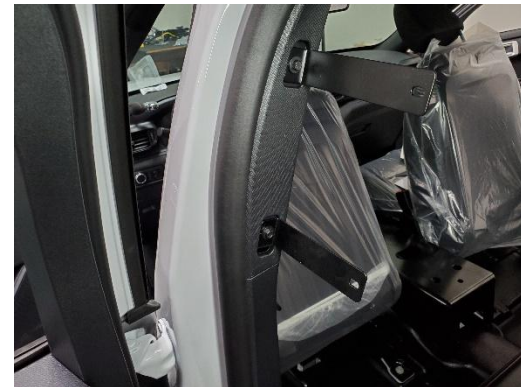

Prior to front bulkhead installation, remove OEM "B" pillar grab handles. Attach upper front bulkhead flat "L" bracket to "B" pillar with OEM grab handle screws. (Longer bracket on top with "L" flange facing out as shown)



With the help of a second person, carefully place front bulkhead into vehicle. Take care not to scratch floor.



Loosely attach front bulkhead to "B" pillar brackets with 1/4" x 1/2" carriage bolts and serrated flange nuts. Bracket goes on inside of bulkhead flange.



Attach front bulkhead to floor using (4) 1/4" x 3/4" carriage bolts and serrated nuts.

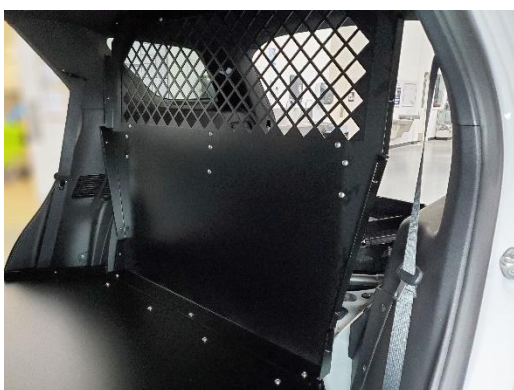

Carefully place rear bulkhead into vehicle and line up to holes in floor. Loosely attach with (3) 1/4" x 3/4" Phillips head bolts and 1/4" flat washers.



Place ceiling on top of front and rear bulkheads. Loosely attach ceiling to bulkheads with 1/4 x 3/4 pan head Phillips bolts and flat washers.



Attach upper rear side filler panel using (4) 1/4" x 3/4" Philips head bolts and 1/4" flat washers  
**Repeat for other side.**

**SDS-2 INSTALLATION**  
**SKIP THIS PAGE IF NOT**  
**INSTALLING SDS**



Loosely attach divider (55285/55286) to ceiling using three (3) 1/4" x 3/4" Phillips pan head machine bolts and flat washers.

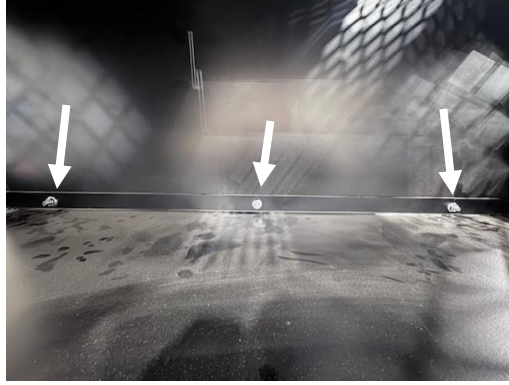

Loosely attach top shelf (55287/55288) to divider using three (3) 1/4" x 1/2" carriage bolts (inserted from K9 side) and serrated nuts.

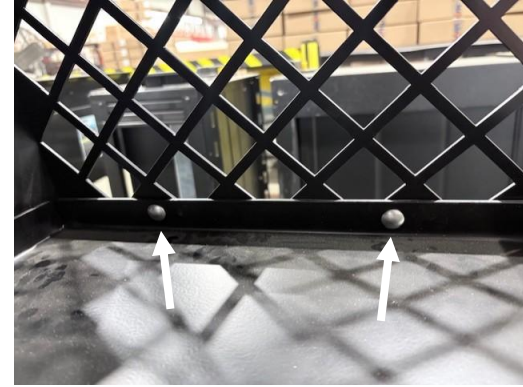

Loosely attach top shelf to front bulkhead using two (2) 1/4" x 1/2" carriage bolts and serrated nuts.



Loosely attach top shelf to rear bulkhead/rear window screen using two (2) 1/4" x 1/2" carriage bolts and serrated nuts.

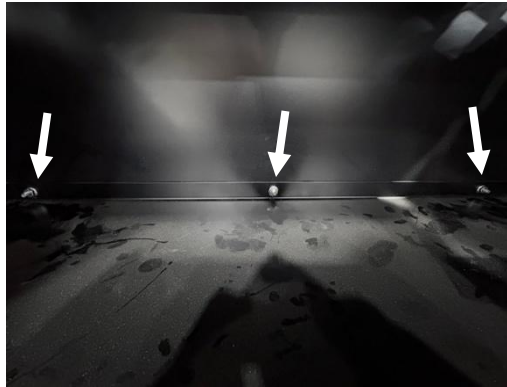

Loosely attach bottom shelf (55291/55292) to divider using three (3) 1/4" x 1/2" carriage bolts (inserted from K9 side) and serrated nuts.

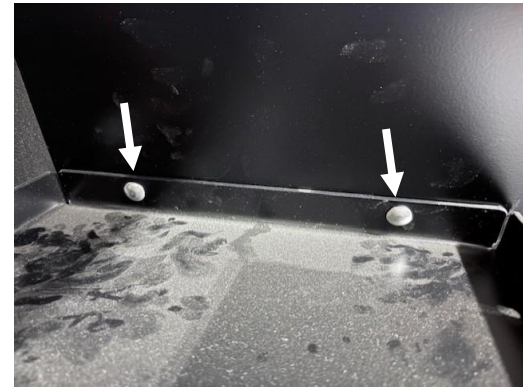

Loosely attach bottom shelf to front bulkhead using two (2) 1/4" x 1/2" carriage bolts and serrated nuts.

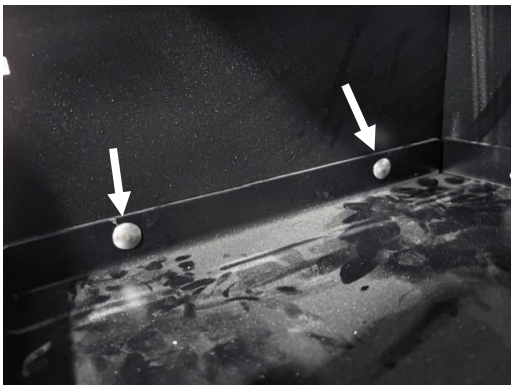

Loosely attach bottom shelf to rear bulkhead using two (2) 1/4" x 1/2" carriage bolts and serrated nuts.

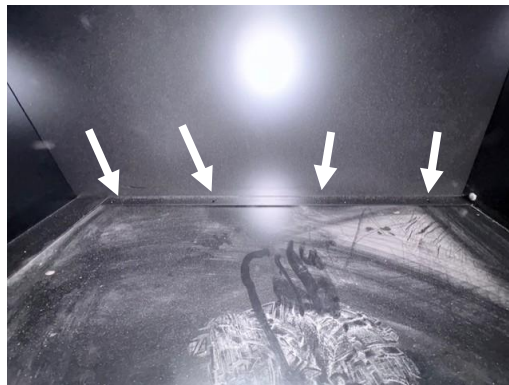

Once everything is tight, secure bottom of divider to K9 floor using four (4) 1/4" x 3/4" self-threading screws.

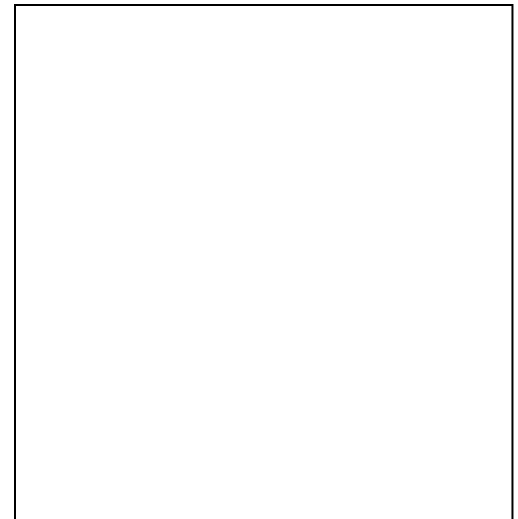

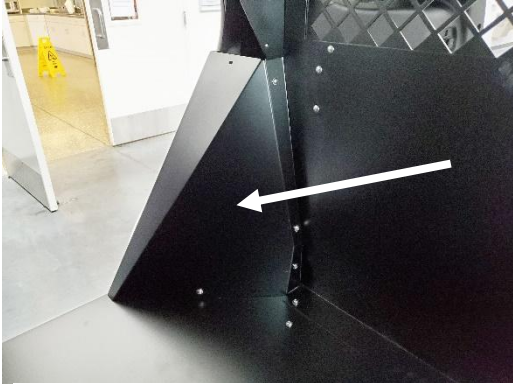

Attach lower trim panel using (4) 1/4" x 3/4" Philips head bolts and 1/4" flat washers.  
**Repeat for other side.**

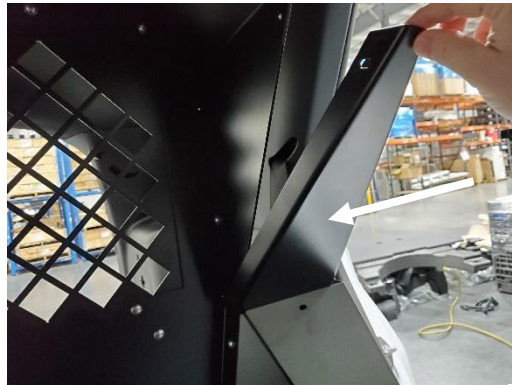

Attach upper rear trim panel to upper rear filler and lower trim panel using (3) 1/4" x 3/4" Philips head bolts and 1/4" flat washers.  
**Repeat for other side.**



Attach side ceiling trim panel using (3) 1/4" x 3/4" Philips head bolts and 1/4" flat washers and (1) 1/4" x 3/4" carriage bolt and serrated nut.  
**Repeat for other side.**  
**Double check and tighten all hardware.**

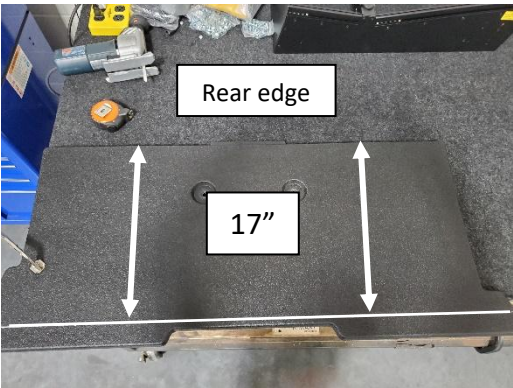

Mark forward floor section 17" inches from rear edge or 2" inches from front edge.



Cut 2" inches off the front of forward floor with a jigsaw or similar cutting tool.



Mark foam along line shown and cut off approximately 4.5" inches.



Place foam into vehicle and trim if needed.

**Note: Leave small gap between foam and bulkhead to prevent future foam on metal squeaking.**

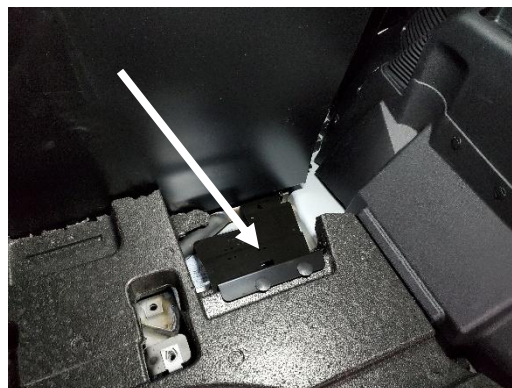

Reinstall OEM optional "Ready for the Road" equipment brackets back onto foam.

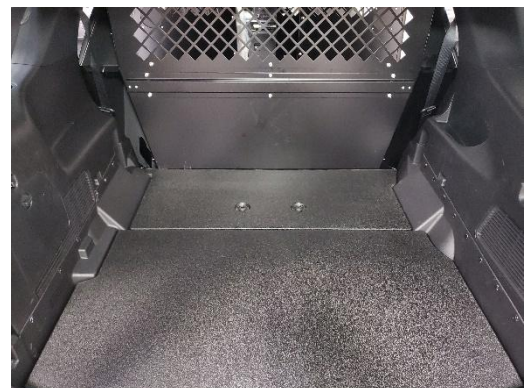

Reinstall OEM rear floor and tighten hardware.



Example mounting location for the optional air circulation fan.

# K9-A-102



Neatly silicone / caulk the lower seams to shed water out of vehicle.

**Note:** The floor is designed to minimize the need for sealant. Caulk (sealant) is mostly needed where the floor meets the door sill and lower trim panels.



Driver side window guard with optional 10" fan mount kit shown.

Fan and window mount kit part number **K9-A-104**

**\*\*Kit includes K9-A-301 fan and WG1007335 mount with hardware\*\***

**K9-A-104** also works on Passenger side window guard.



Confirm smooth slide and lock functionality of front egress door.

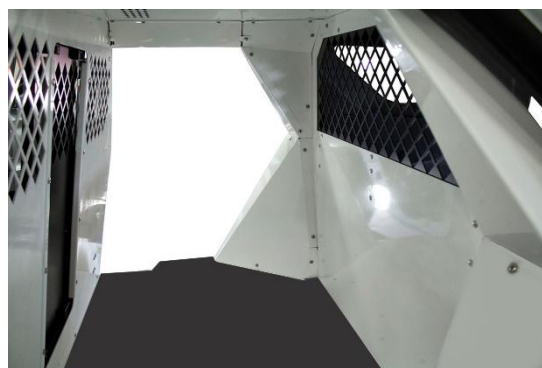

Place rubber mat into insert when silicone is dry. Installation is now complete.

