

# General Prisoner Transport Install Instructions

## PT-3-INST

50" or 60" high x 80", 100" & 120" inch long / Triple Compartment Inserts

Also refer to

PT-A-3XX instructions for vehicle specific mounting measurements and insert parts details

PT-A-1XX and PT-A-2XX Step Instructions

All optional equipment kits include instructions

**Read all instructions before starting insert installation.**

### TOOLS REQUIRED:

Standard and Metric Socket Sets	Awe or Scribe	Tape Measure
Impact Gun (recommended)	Pry-bar	Caulk gun
Power Drill & drill bits	Wire Cutter / Crimping tool	Utility knife
Phillips Screwdriver	Circular saw (for plywood)	

### **HARDWARE KIT # KKM007452 - 60" or 80" Rear Compartment: (Some hardware not used in all applications)**

<u>QTY</u>	<u>DESCRIPTION</u>	<u>PART #</u>	<u>USED FOR:</u>
60	1/4" x 3/4" Carriage bolt	GSM32026	Main Housing
80	1/4" Serrated nut	GSM30170	Main Housing
25	#10 x1-1/4" Phillips pan head sheet metal screw	GSM33197	Floor
25	#10 x 3/4" Phillips self-drilling sheet metal screw	GSM33504	Wall to ceiling
12	#10 x 3/4" Phillips flat head screw	GSM34156	Vent plates/dome lights
10	#10 x 1/2" Phillips flat head screw	GSM33150	AC cover to wall (driver side rear)
32	1/4" x 3/4" Phillips flat head machine screw	GSM33087	Wall/Bench extension
25	1/4" x 3/4" Hex head bolt	GSM32980	3 <sup>rd</sup> divider, 3 <sup>rd</sup> ceiling
25	1/4" Flat washer	GSM31000	3 <sup>rd</sup> divider, 3 <sup>rd</sup> ceiling
15	1/2" Flat washer	GSM31009	Grab straps/seat belts
15	1/2" Lock washer	GSM31030	Grab straps/seat belts
15	1/2" x 1-3/4" Socket button head bolt	GSM33315	Grab straps/seat belts
5	Mounting /Backing plate	KKM007376	Bulkheads
5	3/8" x 2-1/4" Grade 8 Hex head bolt	GSM34023	Bulkheads
5	3/8" Grade 8 Hex nut	GSM30171	Bulkheads
5	3/8" Lock washer	GSM31028	Bulkheads
5	3/8" x 1" Fender washer	GSM31144	Bulkheads
5	3/8" x 1.625" Fender washer	GSM31149	Bulkheads
1	White Silicone tube	PRM97343	Seams & Gaps
4	Lock key	PRM97660-1	Doors
4	Vent block off plate	KKM0403-004	Ceiling (vent adapter kit)
1	Dome lights (two per kit)	KK-DOME-2-LED	Ceiling
1	LABEL - HEAD RESTRAINT	CM007098	Dash
4	LABEL – GRAB STRAPS	KKM99090	PT compartment walls

### **HARDWARE KIT # KKM007453 - 40" Forward Compartment:**

90	1/4" x 3/4" Carriage bolt	GSM32026	Main Housing
90	1/4" Serrated nut	GSM30170	Main Housing
25	#10 x1-1/4" Phillips pan head sheet metal screw	GSM33197	Floor
15	#10 x 3/4" Phillips self-drilling sheet metal screw	GSM33504	Wall to ceiling
12	#10 x 3/4" Phillips flat head screw	GSM34156	Vent plates/dome lights
5	1/2" Flat washer	GSM31009	Grab straps/seat belts
5	1/2" Lock washer	GSM31030	Grab straps/seat belts
5	1/2" x 1-3/4" Socket button head bolt	GSM33315	Grab straps/seat belts

**HARDWARE KIT # KKM007453 - 40" Compartment (continued):**

<u>QTY</u>	<u>DESCRIPTION</u>	<u>PART #</u>	<u>USED FOR:</u>
2	Vent block off plate	KKM0403-004	Ceiling (vent adapter kit)
1	Dome lights (two per kit)	KK-DOME-2-LED	Ceiling
1	LABEL - SAFETY-DRIVE W/ CAUTION	KKM99091	Dash

**HARDWARE KIT # C-HK-277 – Center Divider:**

28	1/4" x 1-1/2" Hex head lag bolt	GSM33062	Divider to floor
7	1/4" x 3/4" Stainless socket button head bolt	GSM33309	Divider to 3 <sup>rd</sup> comp
7	1/4" Stainless flat washer	GSM31048	Divider
14	#10 x 1/2" Phillips flat head machine screw	GSM33380	Door frame to divider
14	#10 Thin Nylock nut	GSM330015-1	Door frame to divider

**OTHER PARTS SHIPPED LOOSE FOR INSTALLATION: X - Quantity depends on model insert**

X	Grab Strap	KKM99068	Bench top
X	Seat belt	PT-A-917	Bench top
X	Seat divider	PT-A-907	Bench top
54	3/16 x .375-.500 Flange Rivets	GSM32101	Seat divider to bench top
X	Door holder assembly (one for each door)	KKM0405-026	Door stop
4	10-32 Keps nut	GSM30123	Door holder bracket
4	10-32 X 3/4 Phillips pan head machine screw	GSM33119	Door holder bracket

**Always!**

- Read all instructions before installing any Havis, Inc. products.
- Check for obstructions (Wire, brake lines, fuel tank, etc.) before drilling any holes!
- Use hardware provided with install kit
- If this is your first time installing a Havis, Inc. Prisoner Transport, please contact the factory for tips and suggestions that will ease the installation.

**VEHICLE PREPERATION:**

**1. STEPS, HVAC, VENT ADAPTOR, OPTIONS, ETC:**

- Refer to the specific install instructions. Installing the steps prior to installing the transport insert will ease installation and **must be done on Chevy and Dodge side step.**
- Installing options may be necessary prior to installing the kit.

**2. SOUND DEADENING & FLOORING:**

- **1/2" or 3/8" plywood is always recommended** to cover the entire cargo floor of the van. (1 ½) – 48" x 96" sheets of plywood are needed. Havis, Inc. does not supply plywood floor kit. **See vehicle specific information in the PT-A-3XX instructions.** Details in these instructions will indicate the starting point / mounting location of the kit.
- **OPTIONAL # PT-A-904** self-adhesive sound deadening wall insulation is sold separately and will greatly help deaden road noise.
- 54" x 20 foot roll of material is simple cut with a razor knife. Peel and stick to walls and ceiling.



Remove wood crate and clear shrink-wrap covering the prisoner transport assembly.



This is the rear 40/60/or 80 section of the kit.



Remove all black hardware, wood panels and brackets holding wood panels



PT-A-300 Trim panel kits, PT-A-100 rear steps, PT-A-200 side steps and other options are shipped inside compartments. Remove equipment and open boxes to review parts and installation instructions.



**Remove only black hardware from assembled unit. This will give you the subassemblies as they are shown on the following pages.**



Primary parts shown after sub-assembly preparation for installation



Driver Side full length Bench/Wall assembly with Front bulkhead wing section.



Passenger Side Rear Bench/Wall/3rd Compartment Bulkhead Wing section



Front Bulkhead minus driver-side wing section



(2) - Diamond plate floor



Center Divider



Driver-side ceiling

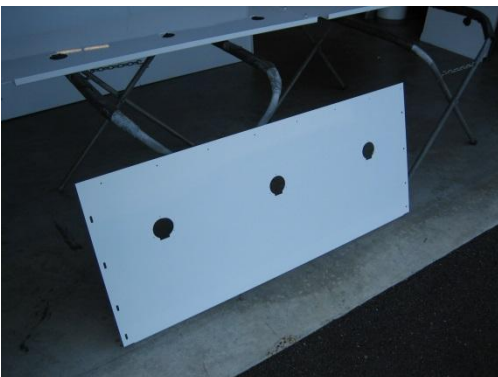

Passenger-side rear ceiling



3rd compartment bulkhead



3rd Compartment bench w/ optional storage door



3<sup>rd</sup> Compartment ceiling



Rear bulkhead/door assembly



3<sup>rd</sup> Compartment  
Bulkhead/door assembly



**Prisoner Transport insert LAYOUT**

*Diamond plate floor and ceiling sections are not shown for detail purposes.*

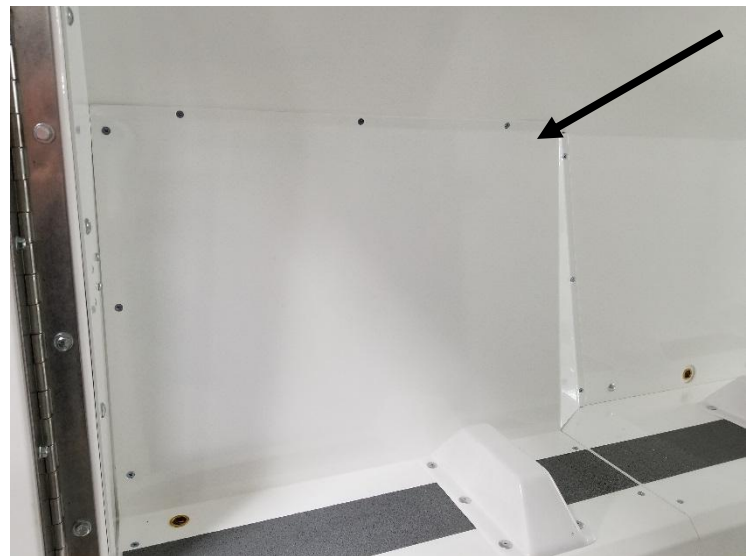

NOTE: The installer must drill the wall for the upper mounting screws of the rear AC blower cover. Drill with 1/8" drill bit and attach with the supplied # 10 x 3/4" flat head sheet metal screws



If optional rear load light(s) (PT-A-916) was ordered, install at this time.

See PT-A-916 install instructions



Install optional PT-A-919 wire harness for dome lights, power vents, video system, HVAC, etc.



For neatness of wiring, route all cables down driver-side "B" pillar. From this location, wires can be run to center console, under dash or to battery location.



Be sure to tape harnesses to roof in approximate locations that accessories are being installed into insert. This will vary between the different model kits.



Install PT-A-4XX HVAC or PT-A-5XX and PT-A-904 at this time. This and other optional equipment wiring must be installed prior to insert



If optional Power Vent(s) (PT-A-921) was ordered, see those specific instructions for necessary prep work that may need to be done prior to installing insert.

**Dome Light Note:** 80" long inserts include two (2) LED dome lights.

100" and 120" long inserts include four (4) LED dome lights.

4.25" diameter block off plates are included to cover unused ceiling holes.

Additional dome lights can be purchased separately if desired. **Order part number PT-A-912**

## Installation of Main Insert Assembly

**\*\* Refer to PT-A-3XX instructions for vehicle specific mounting and parts details \*\***

**\*\*\* See instructions included with optional accessories for installation details \*\*\***

**\*\*\*If OEM "B" pillar upper foam blocks are in the way of front bulkhead installation, cut and remove as little of the foam as needed. Do not completely remove foam blocks\*\*\***

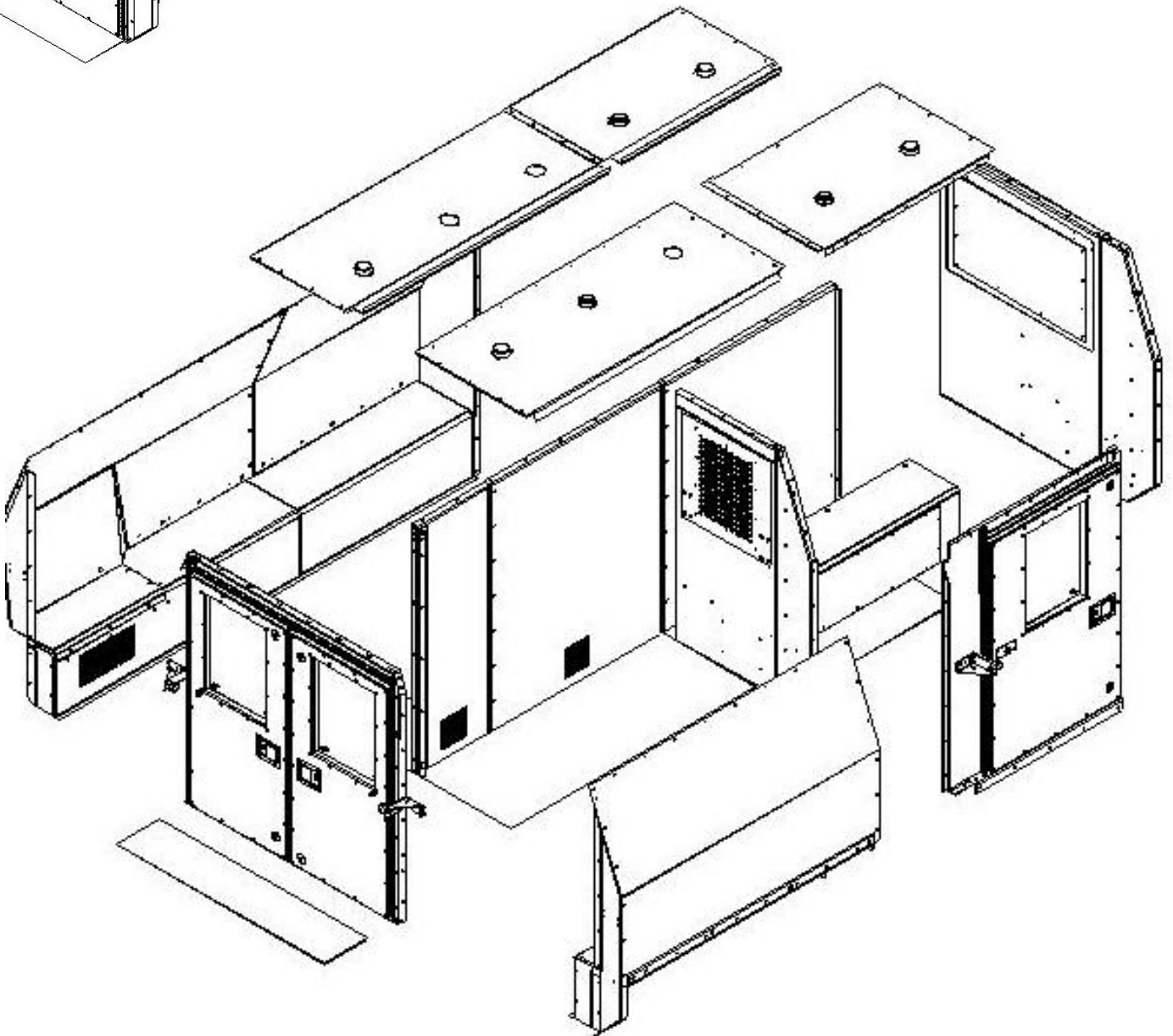
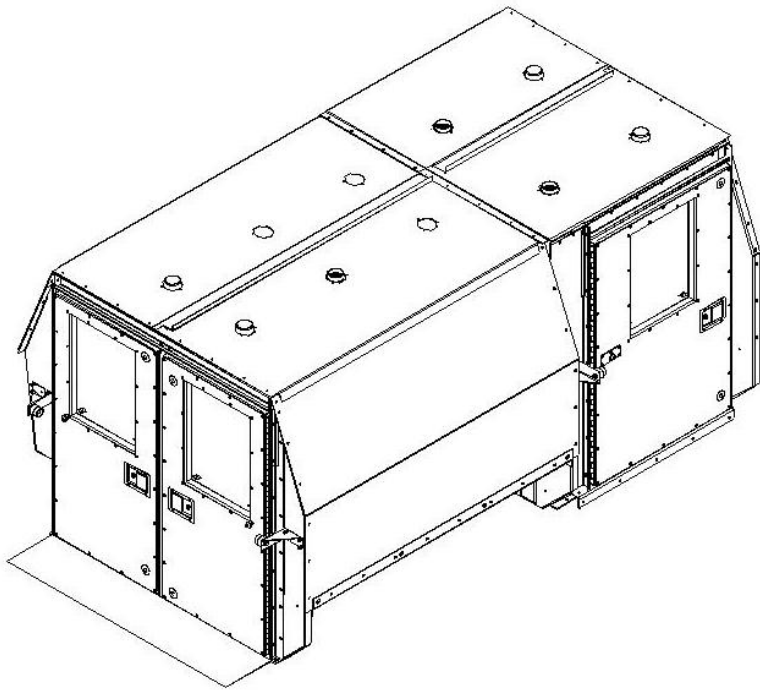



### **CAUTION! FLOOR MOUNT SCREW DETAILS**

The PT Insert kits include #10 x 1-1/4" Phillips pan head sheet metal screws for attaching diamond floor or bench and floor to 1/2" Plywood and OEM sheet metal floor.

The PT insert also includes 1/4" x 1-1/2" Hex head lag bolt for attaching center divider to diamond floor, 1/2" Plywood and OEM sheet metal floor.

These screw lengths are important so they can reach the low portion of the ribbed floor and will also not be too long. In some locations the floor screws may hit the high spot on the rib and penetrate further under the OEM floor. In most areas this is not a concern because screws are above the frame rail, behind a guard or far enough away from fuel tank and other OEM equipment.

When screwing down the floor in a single compartment insert, we recommend three (3) rows of #10 x 1 1/4" screws. One row front to back through each bench lip, diamond plate, plywood and OEM sheet metal. One row front to back in the center through diamond plate, plywood and OEM sheet metal.

There is no need to install floor screws in the center if a Center Divider is being installed.

The 1/4" x 1-1/2" Hex head lag bolts for the divider will fasten everything as needed.

Screws or bolts should be installed in rows at approximate locations shown in **green**.

Do not install screws in area above fuel tank shown in **red**.

#10 x 3/4" flat head sheet metal screws are recommended for attaching plywood to OEM floor.

Only four (4) screws per piece of plywood are necessary for keeping wood in position prior to sheet metal installation. Screws for attaching plywood and plywood are not included with kit.

**DO NOT USE LONGER SCREWS THAN WHAT ARE SUPPLIED OR RECOMMENDED.  
ALWAYS DOUBLE CHECK UNDERNEATH VEHICLE TO CONFIRM SCREWS ARE IN A SAFE LOCATION.**



Run wiring for dome lights, power vents, emergency lighting or any other accessories needed.



Lay plywood down in van.  
**Refer to PT-A-3XX instructions for measurements.**  
Attach hoses from PT-A-5XX to OEM HVAC system or PT-A-4XX series kit. Run vent hoses along inner roof.



Unbolt all black hardware and stage benches for install.  
Front and rear sections need to be bolted together at this time.



Attach bench endcaps using 1/4" x 3/4" Phillips flat head machine screw. Repeat for other bench.



Install front bulkhead in van and lean against front seats.



Load the driver's side bench assembly into the van and line up to the front bulkhead.



Attach the bench to the front bulkhead using 1/4" x 3/4" carriage bolts and serrated nuts.  
**Do not tighten hardware**



Slide in front floor section



Attach third compartment bench to front bulkhead using 1/4" x 3/4" carriage bolts and serrated nuts.



Slide the half bulkhead into the van



Attach to the third compartment bench using 1/4" x 3/4" carriage bolts and serrated nuts.

***Do not tighten hardware***



Install the passenger side rear bench and wall assembly into the van and line up half bulkhead.



Attach the bench and wall to the bulkhead using 1/4" x 3/4" carriage bolts and serrated nuts.

***Do not tighten hardware***



Roughly square up kit and line up to van side door opening.



Bring third compartment door frame over to van.

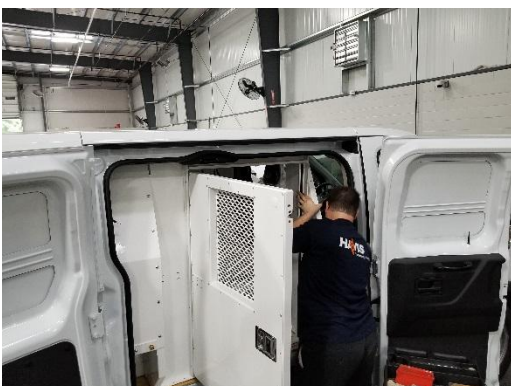

With the help of a second person load the door assembly into the van. Loosely bolt the door to the front and middle bulkhead.

***Do not tighten hardware***



Slide main floor assembly into van and line up to the forward floor. Floor should be sitting on top of lip on benches.



Install the rear door frame assembly into the van and line up to benches.



Attach the door assembly to the benches using 1/4" x 3/4" carriage bolts and serrated nuts.  
**Do not tighten hardware**



Repeat for driver's side.

**Do not tighten hardware**



It is good practice to add some duct tape to the ceiling vent metal hose clamps to avoid rattles.



Install roof panel starting with the driver front first.  
Pull through HVAC hoses and doe light wiring through their respective holes.



Install remaining ceiling panels. Be sure to have the lip of the roof over the back side of the benches.

**Be sure HVAC hoses are not crushed or crossing each other above ceiling panels.**



Attach driver side ceiling panels together using 1/4" x 3/4" Phillips flat head machine screws.



Install 1/4" x 3/4" Hex head bolts and washers through the middle bulkhead and through both ceiling panels. Use alignment tool to help position the holes.



Attach ceiling to front and back bulkheads using 1/4" x 3/4" carriage bolts and serrated nuts.

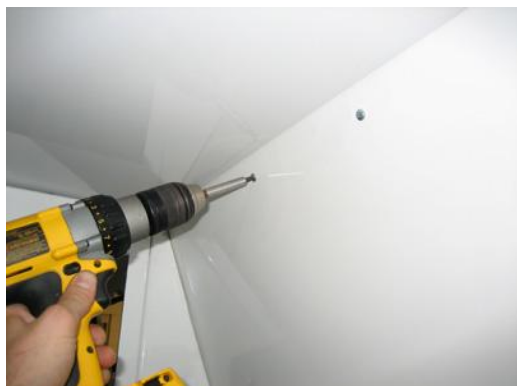

Attach the wall to the ceiling using #10 x 3/4" self-threading screws.



Attach vents to the vent covers with supplied hose clamps.



Wire and mount dome lights in ceiling cutouts



**Check measurements in PT-A-3XX instructions.**  
Center the insert in the van and line up to the measurements.



Drill and temporarily attach the rear lower corner of the door frame with a #10 Phillips sheet metal screw.

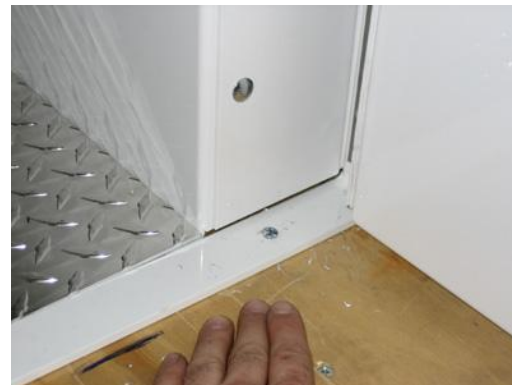

Repeat for other side and the front bulkhead to keep the assembly square.



Attaching Floor  
Measure every 9.5" inches or approximately 7 diamonds and make a mark for the floor screws.



Drill a 3/16" hole through the diamond plate and bench lip only. Do not drill through OEM van floor.



Using a screw gun, install #10 x 1.25" Phillips pan head screws into the floor.



A row down the center is not necessary because the center divider will mount in that space.



With the help of a second installer. Lift the front divider wall section into the van.



Line up to the front bulkhead and third row bench. Bolt to front bulkhead and bench using 1/4" x 3/4" carriage bolts and serrated nuts.



Place middle divider section into van and line up bolt holes to front divider section.



Use alignment tool to help line up middle bulkhead and both dividers. Bolt the panels together using 1/4" x 3/4" stainless socket button head bolt and washer.



Place the rear divider section into the van and line up to middle divider and door frame.



Attach divider sections together with 1/4" x 5/8" stainless socket button head bolts and washers.



Attach divider to door frame using #10 x 1/2" flat head machine screws and nylock nuts. Place weather stripping over bolts.



Install two (2) 1/4" x 3/4" carriage bolts and serrated nuts at the top of rear divider to bulkhead frame.

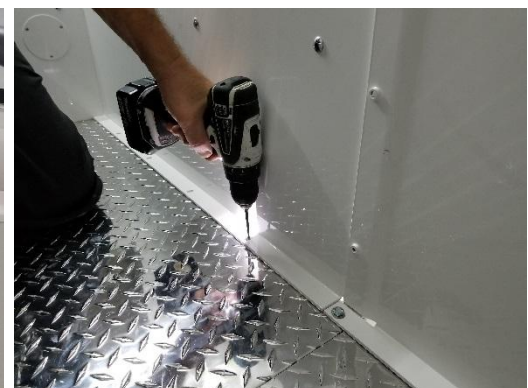

Center and straighten the divider and drill 3/16" holes through diamond plate only. **Do not drill through OEM van floor.**



Attach divider to floor with 1/4" x 1.25" #14 lag bolts.



Repeat process for ceiling.

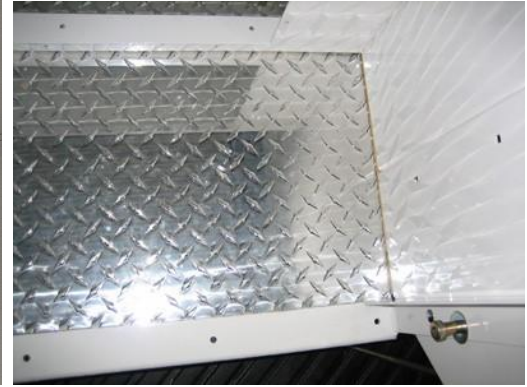

Screw down third compartment door frame with #10 x1-1/4" Phillips screws and install cover over third compartment bench.

***Tighten all hardware***

**Drill 1/8" pilot hole and wax on bolts for easier installation.**



Remove the temporary # 10 screws and drill a 3/8" hole in the corners of the kit for through bolts.

Refer to PT-A-3XX instructions for details.

Always check for obstructions.

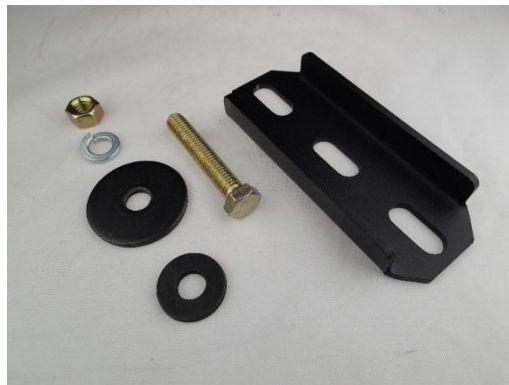

KKM007376 Backing plate and other bulkhead to floor mount hardware shown.



***NOTE: Bulkheads have different holes for mounting. Double check under floor on the van you are working on to confirm correct mounting holes before drilling.***



**Adjust doors as needed for proper alignment to pins. Loosening of the bolts on the hinge to raise or lower the door may be necessary. The latches should meet the pins evenly and engage both stages when closing.**

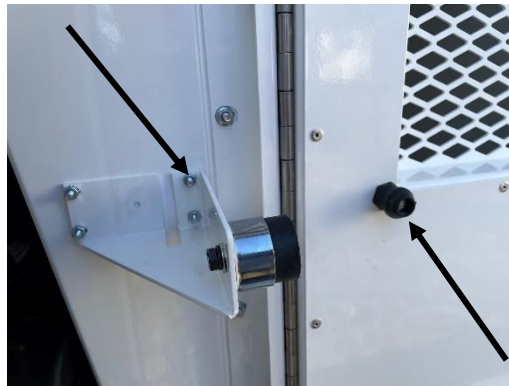

Attach door stop pin to existing 1/4-20 threaded hole in door. Open door and line up door stop "Socket" to pin with bracket attached. Mark locations for the bracket mount holes on bulkhead and drill with 3/16 bit. Attach bracket using #8 x 3/4" Phillips machine screws and nuts.



Double Check and tighten all hardware.

Silicone all seams and joints. This will allow the unit to be hosed out.

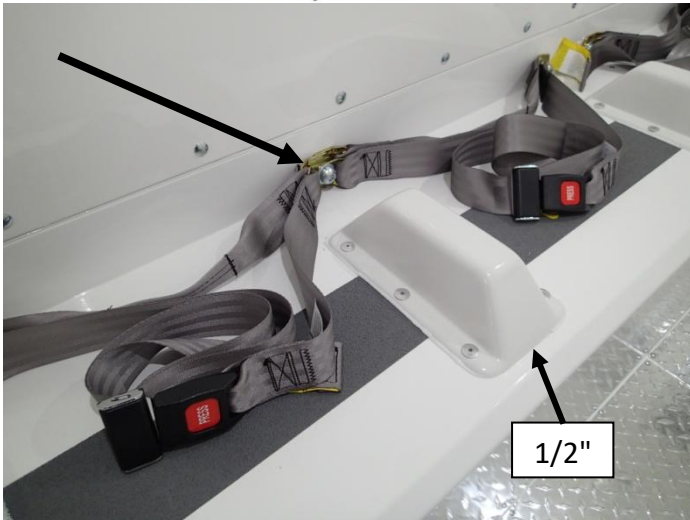

Mount Seat Belts and Grab Straps to bench with 1/2" x 1-3/4" bolts, lock washers and flat washers. **Install with belt strap towards rear for ease of Officer tightening.**

Install seat dividers as per PT-A-907 instructions. **Note:** Seat divider should be placed 1/2" back from seat front bend. Drivers side rear Seat Divider must be mounted rearward of the Seat Belt / Grab Strap mount hardware. All other Dividers will be in line with belt hardware.



Side / 3<sup>rd</sup> compartment bench is not as deep as other benches. Make sure you position the divider to allow space for mount hardware. **Note: Depending on how the end user chooses to use the side / 3<sup>rd</sup> compartment, installation of the seat divider may not be desired in this small compartment.**

Attach Safety label to dash  
**Drive with Extra Caution While Transporting Passengers**

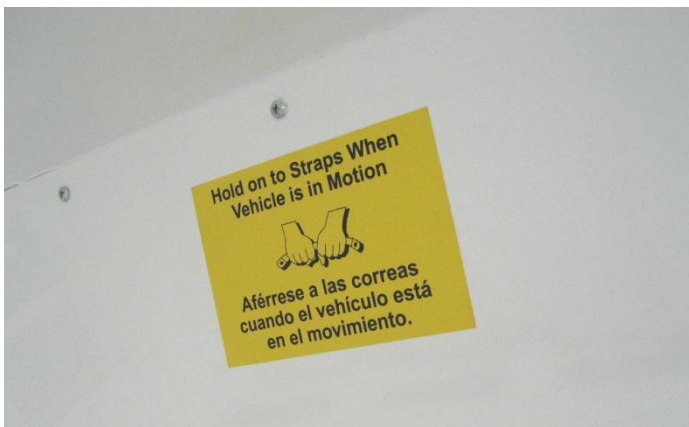

Attach four (4) Safety labels to Center Divider or walls.  
**Hold onto Straps While Vehicle is in Motion**

Attach Safety label to dash  
**The Adjustable Head Restraint is a Safety Device. Adjust the Head Restraint as per Owner's Manual Prior to Operating This Vehicle.**

**PRISONER TRANSPORT OPTIONS – (All SOLD SEPERATLEY)**



Flip Down Step PT-A-902

See caution notes for Transit and Promaster vans.



Power Vent PT-A-921



Sound Deadening Insulation PT-A-904



Rear Load Light PT-A-916



Under bench storage PT-A-906



C-2410 console with C-B68 mount kit.

Transit Van shown

PT-3\_INST\_4-26